

**ACCESSORIES / ZUBEHÖR**  
Item no. 20501

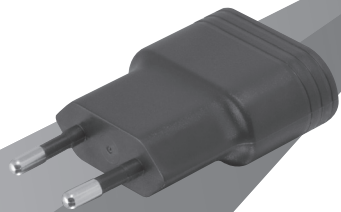

**Charger**  
Ladegerät

**ACCESSORIES / ZUBEHÖR**  
Item no. 18460



**Charging cable USB-C**  
USB-C Ladekabel

**ACCESSORIES / ZUBEHÖR**  
Item no. 00152

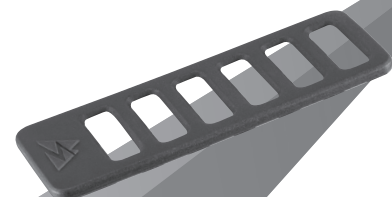

**Silicone Bracket**  
Silikonhalterung

**WARNING / WARNHINWEIS!**

Possibly dangerous optical radiation! Never look directly into the lamp or point it at other people's eyes while it is in operation.

Möglicherweise gefährliche optische Strahlung! Schauen Sie bei Betrieb niemals direkt in die Lampe oder richten diese niemals auf die Augen von anderen Personen.



**UKCA STATEMENT**

We, SIGMA-ELEKTRO GmbH, declare that the equipment above has been tested in our facility and found compliance with the requirement limits of applicable standards, in accordance with the Electromagnetic Compatibility Regulations 2016 and the Restriction of the Use of Certain Hazardous Substances in Electrical and Electronic Equipment Regulations 2012. The test record, data evaluation and Equipment Under Test (EUT) configurations represented herein are true and accurate under the standards herein specified.



**CE INFORMATION**

**EN** SIGMA-ELEKTRO GmbH hereby declares that the BUSTER RL 150 comply with the fundamental requirements and other relevant regulations of Directive 2014/30/EU and RoHS Directive 2011/65/EU. You can find the CE declaration at: [ce.sigmasport.com/busterrl150](http://ce.sigmasport.com/busterrl150)

**DE** Hiermit erklärt SIGMA-ELEKTRO GmbH, dass sich die BUSTER RL 150 in Übereinstimmung mit den grundlegenden Anforderungen und den anderen relevanten Vorschriften der Richtlinie 2014/30/EU und RoHS Directive 2011/65/EU befinden. Sie finden die Konformitäts-Erklärung unter folgendem Link: [ce.sigmasport.com/busterrl150](http://ce.sigmasport.com/busterrl150)

**FR** Vous trouverez la déclaration CE à l'adresse : [ce.sigmasport.com/busterrl150](http://ce.sigmasport.com/busterrl150)

**IT** La dichiarazione CE è disponibile all'indirizzo: [ce.sigmasport.com/busterrl150](http://ce.sigmasport.com/busterrl150)

**ES** Puede encontrar la declaración de conformidad CE en: [ce.sigmasport.com/busterrl150](http://ce.sigmasport.com/busterrl150)

**NL** Je kunt de CE-certificering vinden op: [ce.sigmasport.com/busterrl150](http://ce.sigmasport.com/busterrl150)

**FCC DECLARATION OF CONFORMITY**



This device complies with Part 15 of the FCC Rules. Operation is subject to the following two conditions: (1) This device may not cause harmful interference, and (2) This device must accept any interference received, including interference that may cause undesired operation. The grantee is not responsible for any changes or modifications not expressly approved by the party responsible for compliance. Such modifications could void the user's authority to operate the equipment. This equipment should be installed and operated with a minimum distance of 5 millimeters between the radiator and your body.

**NOTE:**

This equipment has been tested and found to comply with the limits for a Class B digital device, pursuant to part 15 of the FCC Rules. These limits are designed to provide reasonable protection against harmful interference in a residential installation. This equipment generates, uses and can radiate radio frequency energy and, if not installed and used in accordance with the instructions, may cause harmful interference to radio communications. However, there is no guarantee that interference will not occur in a particular installation. If this equipment does cause harmful interference to radio or television reception, which can be determined by turning the equipment off and on, the user is encouraged to try to correct the interference by one or more of the following measures:  
- Reorient or relocate the receiving antenna.  
- Increase the separation between the equipment and receiver.  
- Connect the equipment into an outlet on a circuit different from that to which the receiver is connected.  
- Consult the dealer or an experienced radio/TV technician for help.

**FCC Caution:**

Any changes or modifications not expressly approved by the party responsible for compliance could void the user's authority to operate this equipment.

**Radiation Exposure Statement:**

The product comply with the FCC portable RF exposure limit set forth for an uncontrolled environment and are safe for intended operation as described in this manual. The further RF exposure reduction can be achieved if the product can be kept as far as possible from the user body or set the device to lower output power if such function is available.



**BUSTER RL 150 LUMENS**



**SIGMA-ELEKTRO GmbH**  
Dr.-Julius-Leber-Straße 15  
67433 Neustadt / Weinstraße  
Germany  
Tel. +49 6321-9120-118  
[kundenservice@sigmasport.com](mailto:kundenservice@sigmasport.com)



## MOUNTING/ MONTAGE

Do not cover the rear light! / Die Lichtverteilung darf nicht verdeckt sein!

1

Before mounting, clean and degrease the seat post to ensure a tight fit. When fixing the device, ensure that the silicone strap is tight enough that the rear light cannot move on its own and is not easily moved. Mounting height between 250 - 1200 mm. /

Vor Montage Sattelstütze reinigen und entfetten, um einen festen Sitz zu gewährleisten. Bei der Befestigung ist darauf zu achten, dass das Silikonband bei Montage so fest angezogen und angebracht wird, dass sich die Rückleuchte weder von selbst verstellen kann noch leicht verstellbar ist. Anbauhöhe 250-1200 mm.

2

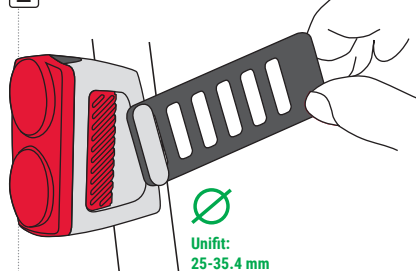

## ALIGNMENT/ AUSRICHTUNG

Final side of the tail lamp perpendicular to the roadway and at right angles to the vehicle center axis. / Abschlussseite der Schlussleuchte senkrecht zur Fahrbahn und rechtwinklig zur Fahrzeugmittellachse.

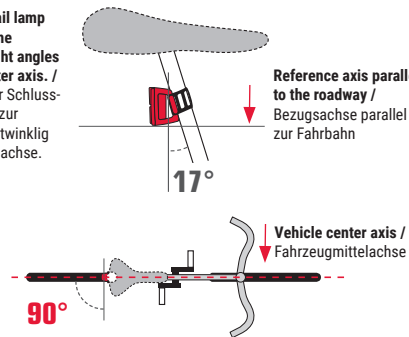

## 5 MODES / 5 MODI

BUTTON	MODE	BRAKELIGHT	LUMENS	RUN TIME
2 x short click	ON / Last Mode	ON		
+ 1 x click	HIGH	✓	≤ 40	≤ 4 h
+ 1 x click	LOW	✓	≤ 5	≤ 20 h
+ 1 x click	DAY FLASHING	✓	≤ 150	≤ 6 h
+ 1 x click	NIGHT FLASHING	✓	≤ 25	≤ 7 h
+ 1 x click	ECD FLASHING	✓	≤ 5	≤ 20 h
1 x long click 2 sec. → OFF				

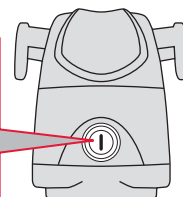

## MODE MEMORY FUNCTION / MODE MEMORY FUNKTION

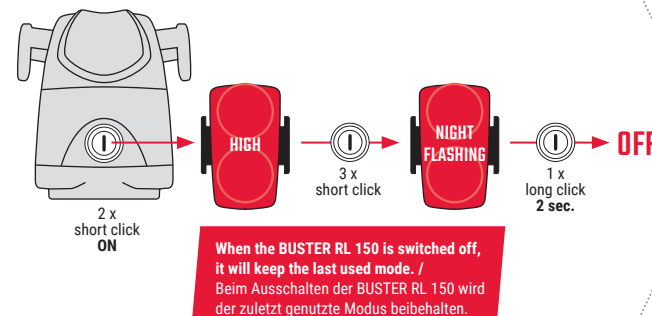

## EXAMPLE / BEISPIEL

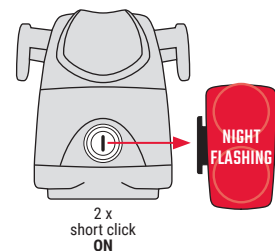

## CALIBRATING THE BRAKE LIGHT / KALIBRIERUNG DES BREMSLICHTS

The BUSTER RL 150 is a self-calibrating kinetic brake light.

Two clicks: the BUSTER RL 150 is switched on and goes to the last lighting mode used. At the same time, the green, yellow and red indicator LEDs in the ON/OFF button flash together, which indicates the calibration. When calibration is finished, the battery indicator shows the battery charge status (green, yellow, or red/ flashing red). /

Die BUSTER RL 150 ist ein selbstkalibrierendes Bremslicht.

2 x Klick: Die BUSTER RL 150 wird eingeschaltet und leuchtet im zuletzt benutzten Modus. Gleichzeitig blinken im ON/OFF Knopf die grüne, gelbe und rote Indikations-LED zusammen, was die Kalibrierung anzeigt. Ist die Kalibrierung abgeschlossen, zeigt die Akku-Indikationsanzeige den Akku-Füllstatus an, also grün, gelb oder rot / rot blinkend.

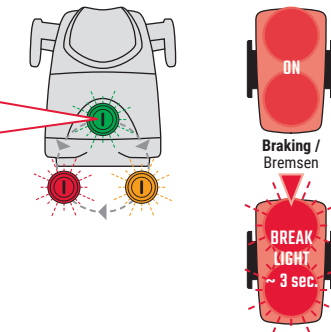

## BATTERY INDICATOR / AKKUINDIKATOR

BATTERY STATUS / AKKU-STATUS

In the switched-off state, 1x short click shows the current battery status. / Im ausgeschalteten Zustand 1x kurzer Klick zeigt den aktuellen Akku-Status an.

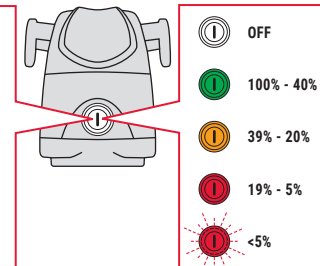

NOTE: If the battery capacity is less than 20 %, the red indicator LED lights up and after about 45 minutes, the red LED begins flashing, and the BUSTER RL 150 goes out completely shortly thereafter. /

HINWEIS: Bei weniger als 20 % Akku-Kapazität leuchtet die rote Indikator-LED auf und nach etwa 45 Min. blinkt die rote LED. In Kürze geht die BUSTER RL 150 komplett aus.

## CHARGING / LADEVORGANG

The lamp needs to be charged at room temperature. (Charging temperature: +10 °C to +45 °C) (50 °F to 110 °F) / Laden Sie die Lampe nur bei Raumtemperatur auf. (Ladetemperatur: +10 °C bis +45 °C)

Ensure that the USB sealing marked red is always closed correctly after charging. / Achten Sie bitte darauf, dass die rot markierte Abdichtung nach dem Ladevorgang stets korrekt verschlossen ist.

No energy can be transferred out through the USB-C connection. / Eine Energieentnahme über den USB-C-Anschluss ist nicht möglich.

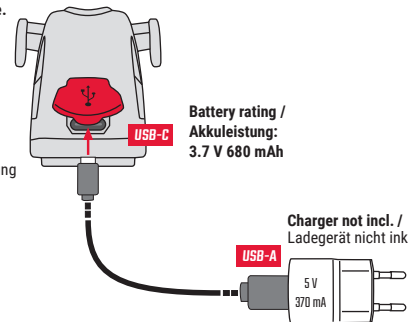

## CHARGING INDICATOR / LADEINDIKATOR

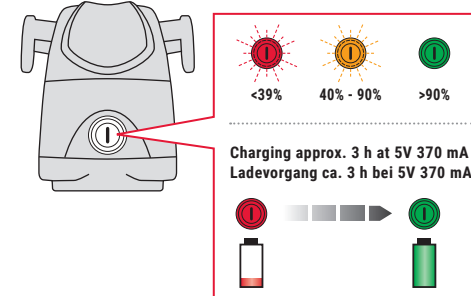

## TECHNICAL DATA / TECHNISCHE DATEN

Charging Temperature: +10 °C to +45 °C (50 °F and 110 °F)

Battery Type: 3.7 V 680 mAh

Max power: 1W

Water and Dust rating: IP44

## VIDEO TUTORIALS

Detailed tutorials and application tips can be found at this link.

Detaillierte Tutorials und Anwendungstipps finden Sie unter diesem Link.

[goto.sigmasport.com/busterrl150/service](https://goto.sigmasport.com/busterrl150/service)

